

Installation via CDROM

1. Insert IFTOOLS CDROM
If the installation does not start automatically, run setup.exe (Windows), setup_x86_64 (Linux 64 bit) or setup_i386 (Linux 32 bit) from the CDROM.

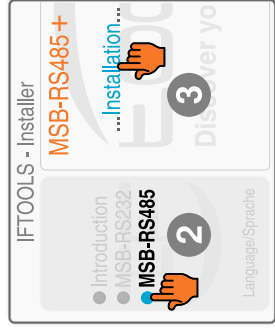

2. Select MSB-RS485 product
3. Click the text link Installation...



4. Follow the installer instructions

Installation via Internet

1. Goto www.iftools.com/download

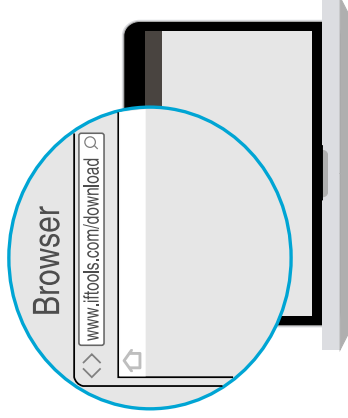

2. Download newest analyzer software
3. Make file executable (only Linux)
4. Run downloaded installer file
5. Follow the installer instructions



First analysing steps

1. Connect analyzer with PC via USB

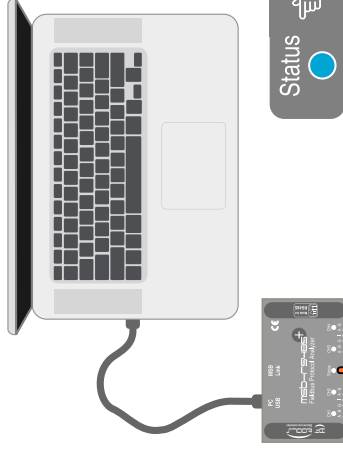

2. Start the analyzer software (click icon)



3. Adapt & Configure bus connection
See also back side

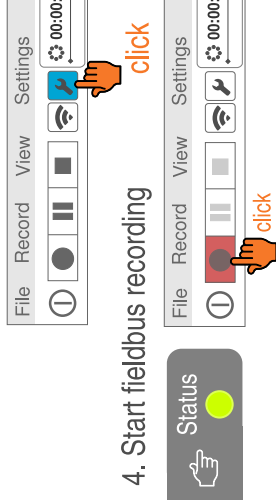

4. Start fieldbus recording



Tapping 2-Wire Bus

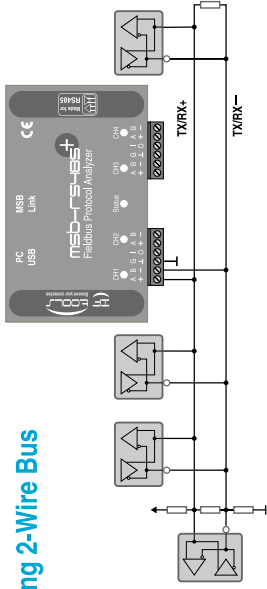

Tapping 4-Wire Bus

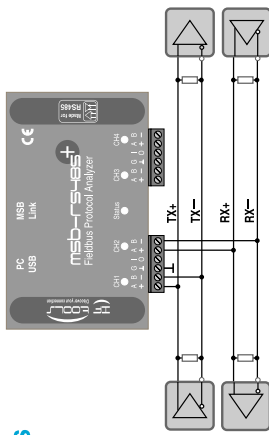

Tapping two 2-Wire Buses

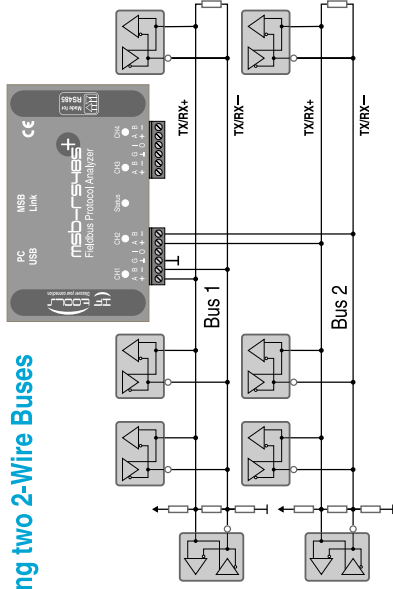

SEGMENT ANALYSIS WITH DATA DIRECTION

Segment Analysis 2-wire bus

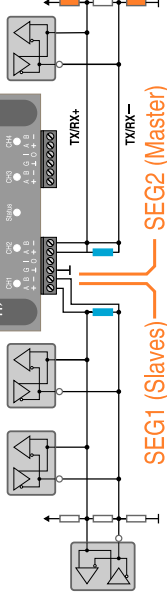

Segment Analyse 4-wire bus

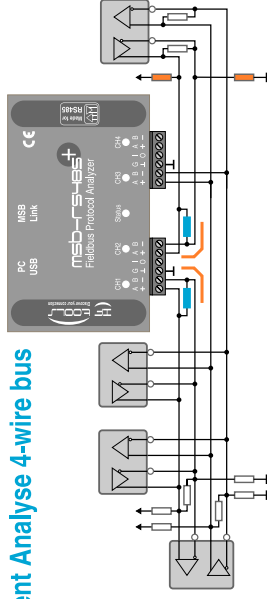

Bus Terminators and Pullup or Pulldown resistors usually part of the bus



120 Ohm Bus Terminator provided and attachable in the analyzer bus settings



Bus Pullup/Down Terminators must be applied by the user according to bus specifications

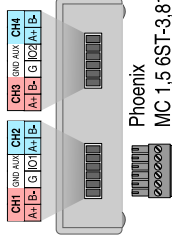

Phoenix
MC 1.5 6ST-3,81

PARALLEL TAPPING